

**DETAILS**

— **BE** —

CISTERN  
PLATES &  
CISTERNS



THE DEBUT COLLECTION



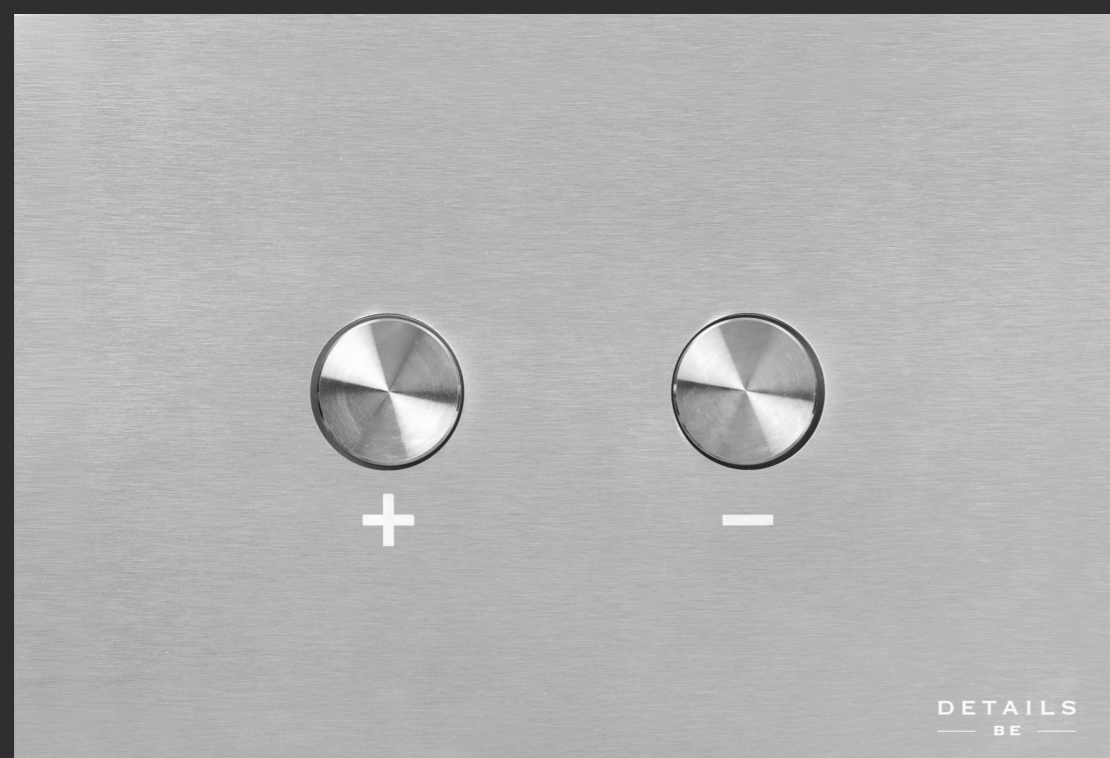

HERE ON WE TAKE CARE OF  
THE DETAILS, SO YOU CAN

JUST BE

## DETAILS — BE —

### CISTERN PLATES

- |   |         |    |
|---|---------|----|
| 1 | HORIZON | 6  |
| 2 | PRISM   | 10 |

### CONCEALED CISTERN

- |   |            |    |
|---|------------|----|
| 1 | PULSE      | 18 |
| 2 | PULSE NANO | 20 |

- |  |                    |    |
|--|--------------------|----|
|  | TECHNICAL DRAWINGS | 22 |
|--|--------------------|----|



**DETAILS B.E.** products are designed using the latest technologies and respecting the pressing environmental issues.

Our meticulously crafted Cistern Plates undergo rigorous testing, ensuring top quality with 36 lab tests conducted. This commitment to excellence has earned us international recognition, including Reddot and IF Design awards.

Our Cistern Plates are available in a choice of luxurious finishes and designs to add that final designer detail to your new bathroom.

**DETAILS B.E.** Cistern Plates are not just beautifully designed; they're engineered to optimize water usage, helping you contribute to a more sustainable future without compromising on style or functionality.



### **WATER SAVING**

We save on average 9lt of water per day, 270lt a month and 3285 in a year



### **90% OF WASTE HAS BEEN RECYCLED**



### **RECYCLED RAW MATERIALS**



### **REDUCTION IN EMISSIONS**

Reduction in emissions by 1000 tonnes of CO2 per year



### **PHOTOVOLTAIC PANELS**



# HORIZON



Sleek and stylish, **DETAILS B.E. HORIZON** cistern plates deliver sophistication with functionality. Its clean minimalistic design blends with any bathroom aesthetic, be it contemporary or traditional. With a gentle press, the cistern plate delivers a powerful flush. The **HORIZON** fits in perfectly in the Indian ecosystem.

It is available in a variety of finishes, including White, Polished Chrome, Satin Chrome, Dual Gold and Brushed Nickel.



# HORIZON

- WHITE 
- SATIN CHROME 
- CHROME 
- BRUSHED CHROME 
- GOLD 

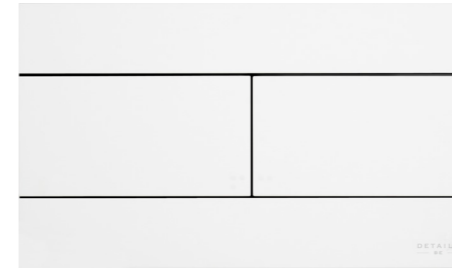

**HORIZON** DUAL CONTROL PLATE  
FCS/FBE/OL065904123FCM *WHITE*



**HORIZON** DUAL CONTROL PLATE  
FCS/FBE/OL065904423FCM *CHROME*

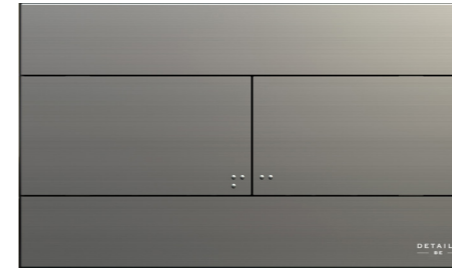

**HORIZON** DUAL CONTROL PLATE  
FCS/FBE/OL065904623FCM  
*SATIN CHROME*



**HORIZON** DUAL CONTROL PLATE  
FCS/FBE/OL005714123FCM  
*BRUSHED CHROME*

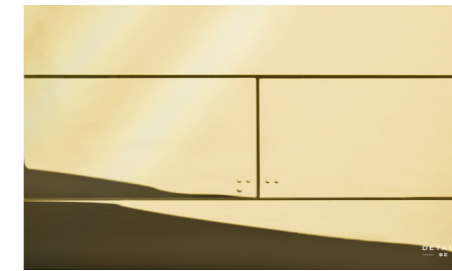

**HORIZON** DUAL CONTROL PLATE  
FCS/FBE/OL015496223FCM *GOLD*



# PRISM

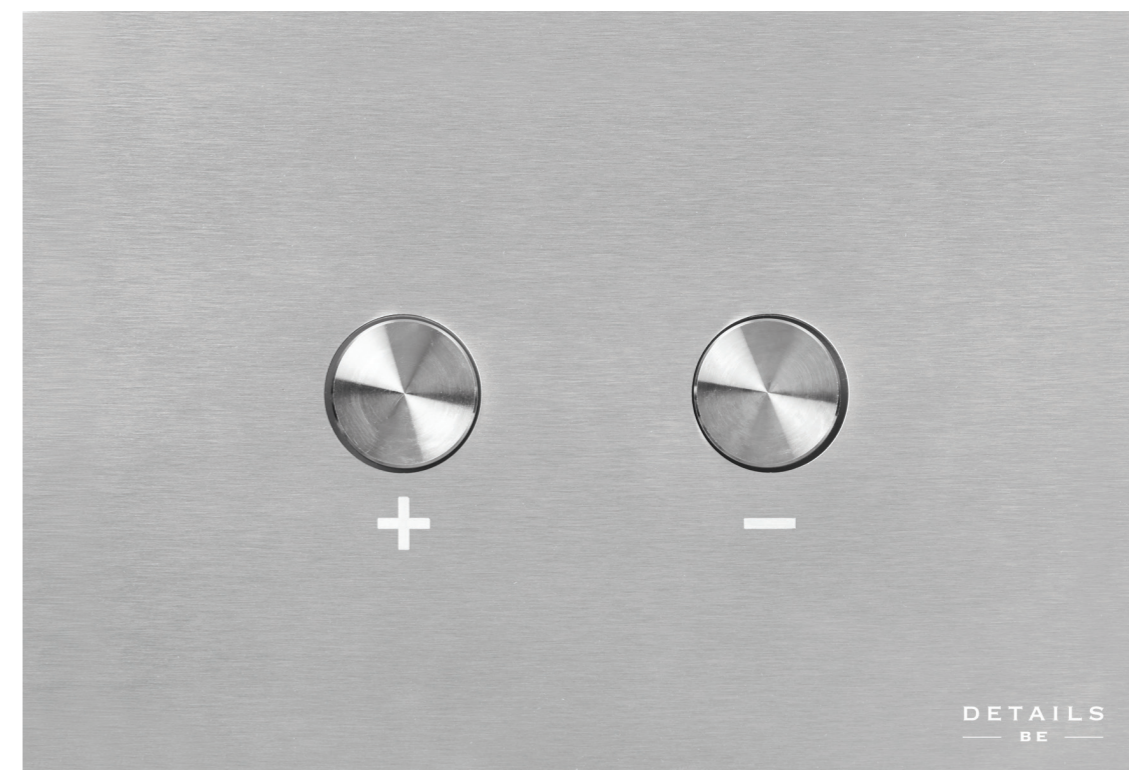

Elegance in daily rituals. **DETAILS B.E.'s PRISM** cistern plate adds design and class to the bathroom. Aesthetically built, with an eye for minimalism, the **PRISM** instantly elevates the bathroom. It is easy to install and comes with the DETAILS B.E. promise of quality, aesthetics and after-sale service.

Available in a multitude of finishes to suit every bathroom, including Brushed Chrome, Polished Chrome, Matt Black, Brushed White Gold, Brushed Gun Metal, Brushed Copper and Gold.



# PRISM

BRUSHED  
CHROME



CHROME



GUN METAL



MATT  
BLACK

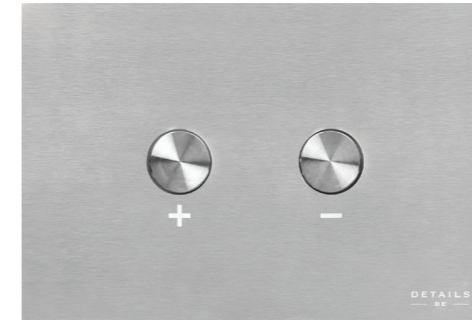
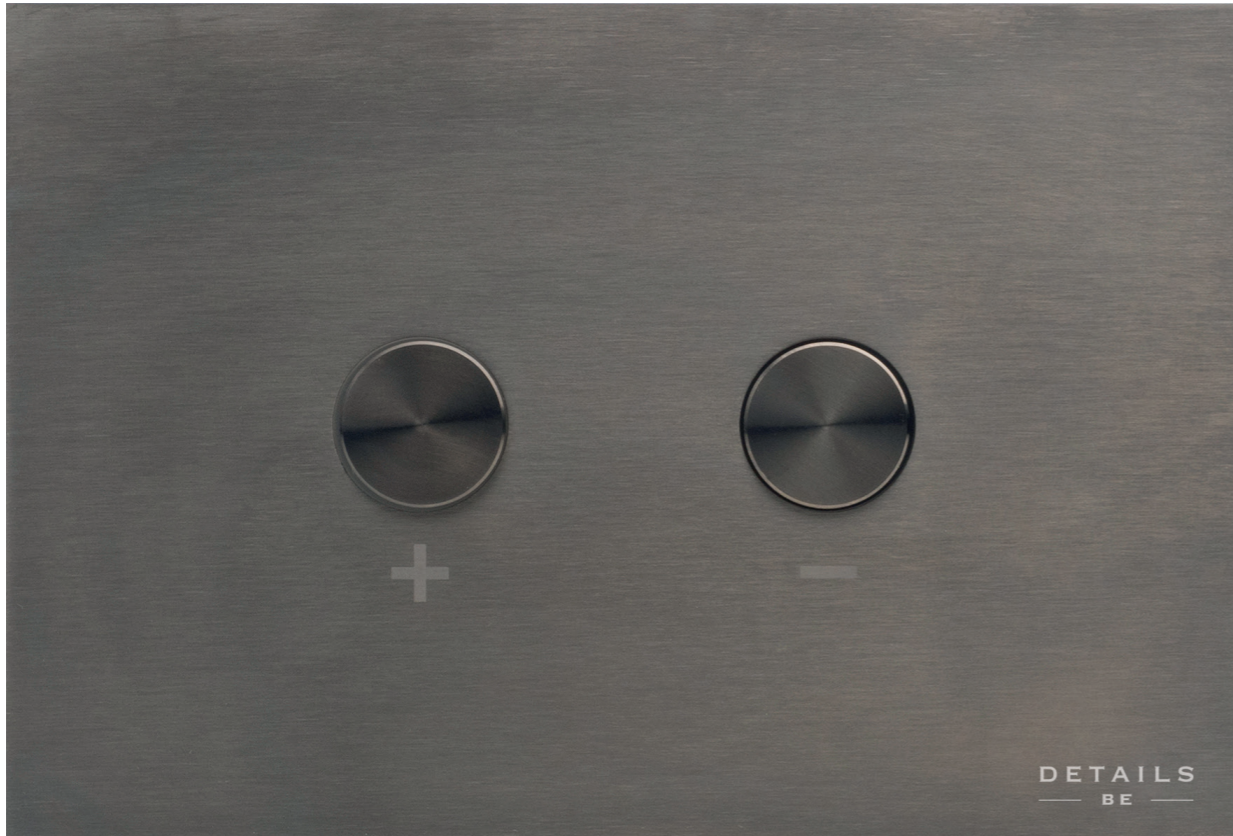

**PRISM INOX CONTROL PLATE**  
FCS/FBE/OL009339923FCM +  
FCS/FBE/OL0055680623FCML  
BRUSHED CHROME

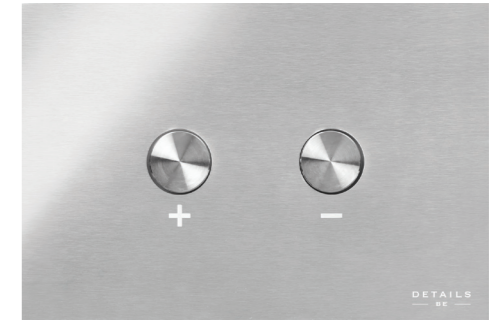

**PRISM INOX CONTROL PLATE**  
FCS/FBE/OL015496323FCM + FCS/  
FBE/OL0055680623FCML CHROME



**PRISM INOX CONTROL PLATE**  
FCS/FBE/OL088256723FCM + FCS/  
FBE/OL0055680623FCML  
GUN METAL

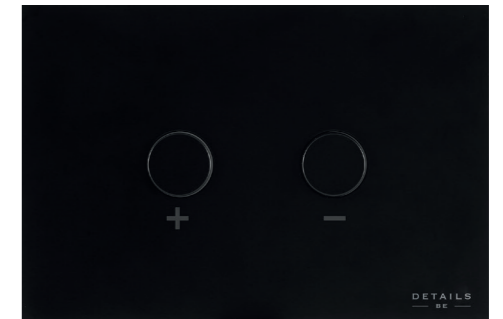

**PRISM INOX CONTROL PLATE**  
FCS/FBE/OL087848923FCM + FCS/  
FBE/OL0055680623FCML  
MATT BLACK



# PRISM

BRUSHED  
GOLD



GOLD



BRUSHED  
COPPER



**PRISM INOX CONTROL PLATE**  
FCS/FBE/OL087878123FCM +  
FCS/FBE/OL0055680623FCML  
BRUSHED GOLD



**PRISM INOX CONTROL PLATE**  
FCS/FBE/OL088324623FCM +  
FCS/FBE/OL0055680623FCML  
GOLD

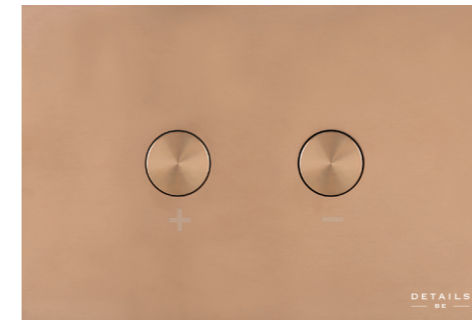

**PRISM INOX CONTROL PLATE**  
FCS/FBE/OL087878223FCM +  
FCS/FBE/OL0055680623FCML  
BRUSHED COPPER





# CONCEALED CISTERN

Introducing the **Cisterns** from **DETAILS B.E.**, where efficiency meets functionality seamlessly. The concealed WC cisterns, including the **PULSE** and **PULSE NANO**, are designed for effortless installation and support a robust frame.

These products enhance our wellness ecosystem, ensuring long-lasting performance and easy maintenance. Elevate your bathroom experience with Cistens, where quality and durability are paramount.



# PULSE

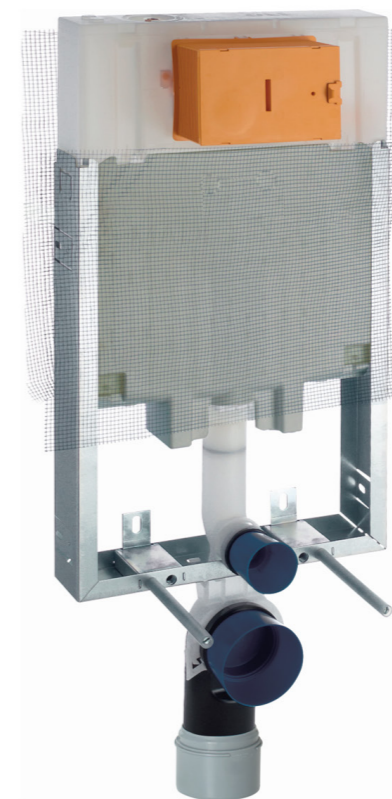

**PULSE CISTERN**  
FCS/FBE/OL088511023FCM  
760 X 422 X 80 MM (HXWXD)

**DETAILS B.E.** introduces a superior range of technical products that elevate efficiency and functionality, while perfectly fitting into our wellness ecosystem. The **PULSE** concealed WC cistern is an ideal companion for wall-hung toilets.

It is a match for solid or dry-wall installation and can support a frame of upto 400 kilograms. The PULSE range of technical products are built for easy and quick installation, that will last a long time.



# PULSE NANO



**PULSE NANO** CISTERN  
FCS/FBE/OL088507023FCM  
580 X 420 X 80 MM (HXWXD)

**DETAILS B.E.** introduces a superior range of technical products that elevate efficiency and functionality, while perfectly fitting into our wellness ecosystem. The **PULSE NANO** is a concealed WC cistern mechanism that is built for easy and quick installation. It is built for durability and ease of maintenance.



# TECHNICAL DRAWINGS



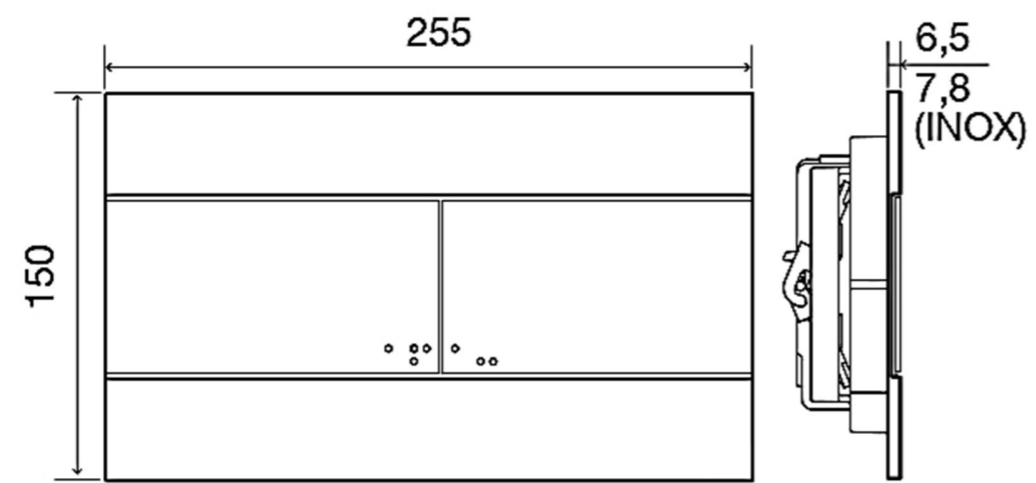

**HORIZON CISTERN PLATE** 255 X 150 MM

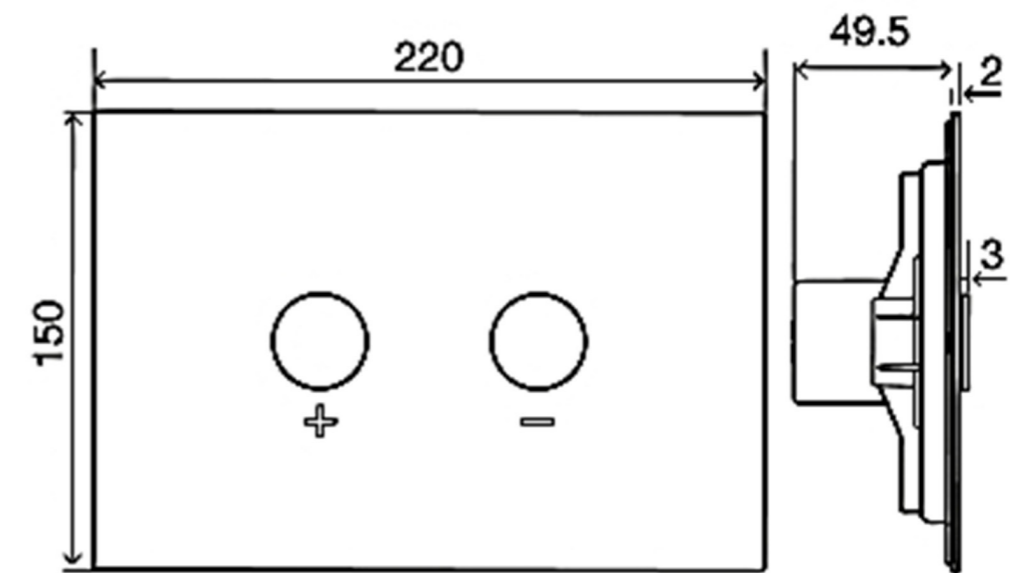

**PRISM CISTERN PLATE** 250 X 150 MM

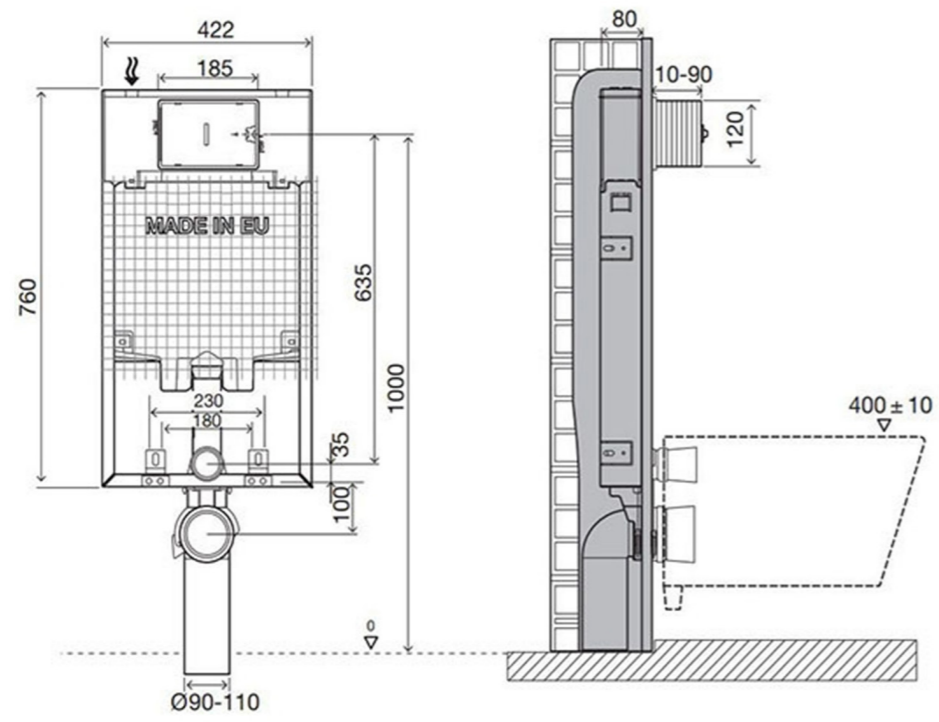

**PULSE CISTERN** 760 X 422 X 80 MM

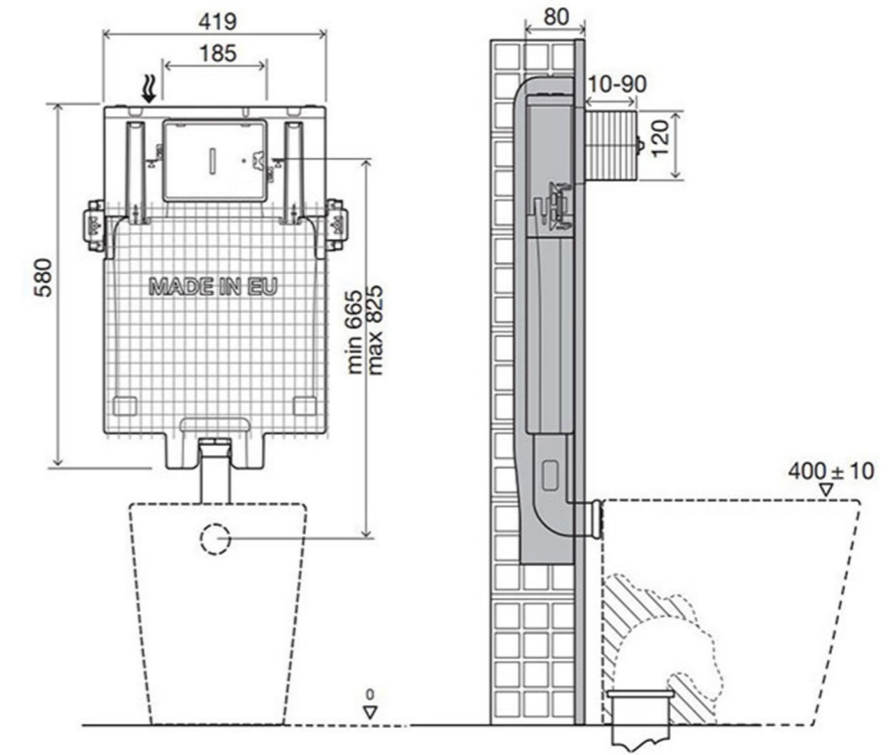

**PULSE NANO CISTERN** 580 X 420 X 80 MM



# DETAILS — BE —

BATHWARE | BATH ACCESSORIES | VISO STEAM GENERATORS  
CISTERN & CISTERN PLATES



[WWW.DETAILSBE.COM](http://WWW.DETAILSBE.COM)



1800-8333566



[CONTACT@DETAILSBE.COM](mailto:CONTACT@DETAILSBE.COM)



[DETAILSBEBYFCML](https://www.instagram.com/DETAILSBEBYFCML)